

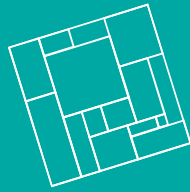

TRANSFORMING
GIMMROFSNART

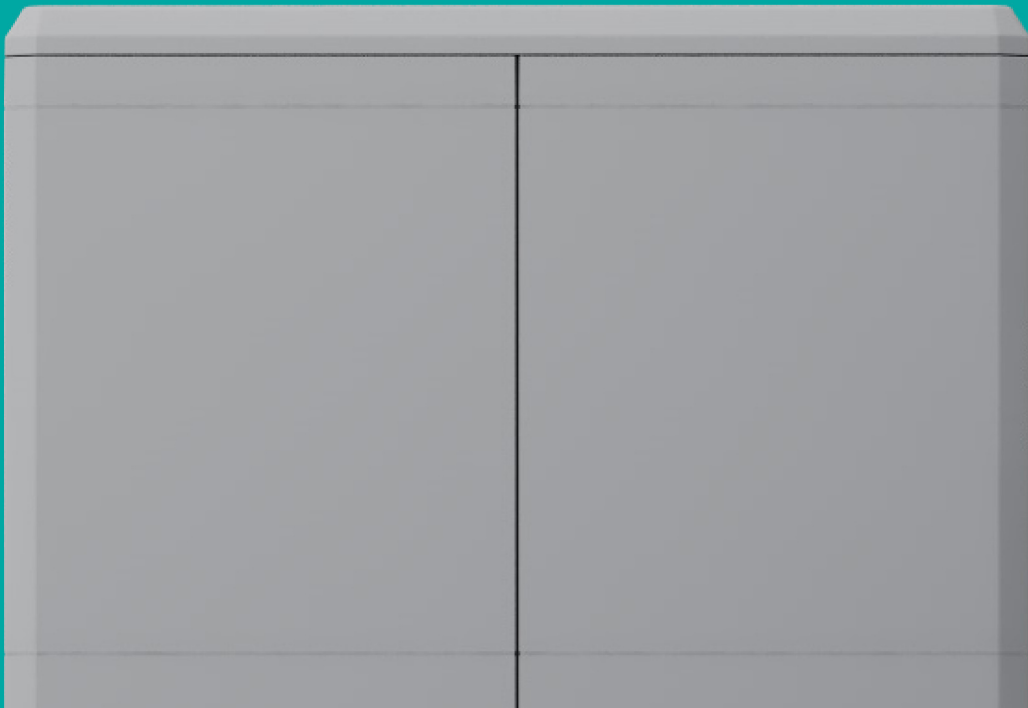

TRANSFORMING
Terry



Imagine a cabinet that
fits your needs
and **changes** with you

Immagina un armadio che si adatta e si trasforma insieme a te
Imaginez une armoire qui s'adapte et se transforme avec vous
Stellen Sie sich einen Schrank vor, der sich Ihnen Bedürfnissen entsprechend anpasst
Imagina un armario que se adapta a tus necesidades.

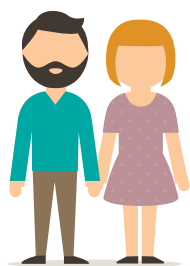
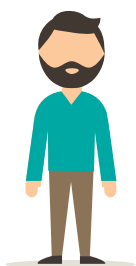

Metal Hinges for easy opening and closing.

Cerniere Metallo che facilitano l'apertura e la chiusura delle ante.
Charnières en métal pour faciliter l'ouverture et la fermeture des portes.
Metallscharniere erleichtern das Öffnen und Schließen der Türen.
Bisagras metálicas para facilitar apertura y cierre de puertas.



Bi-component handle
Maniglia in materiale bicomponente
Poignée bimatière
Bikomponenten-Griffe
Asas en bimatèrial

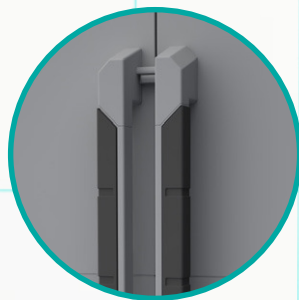

Height adjustable feet
Piedi regolabili in altezza
Pieds réglables en hauteur
In Höhe verstellbare FüÙe
Pies Ajustables

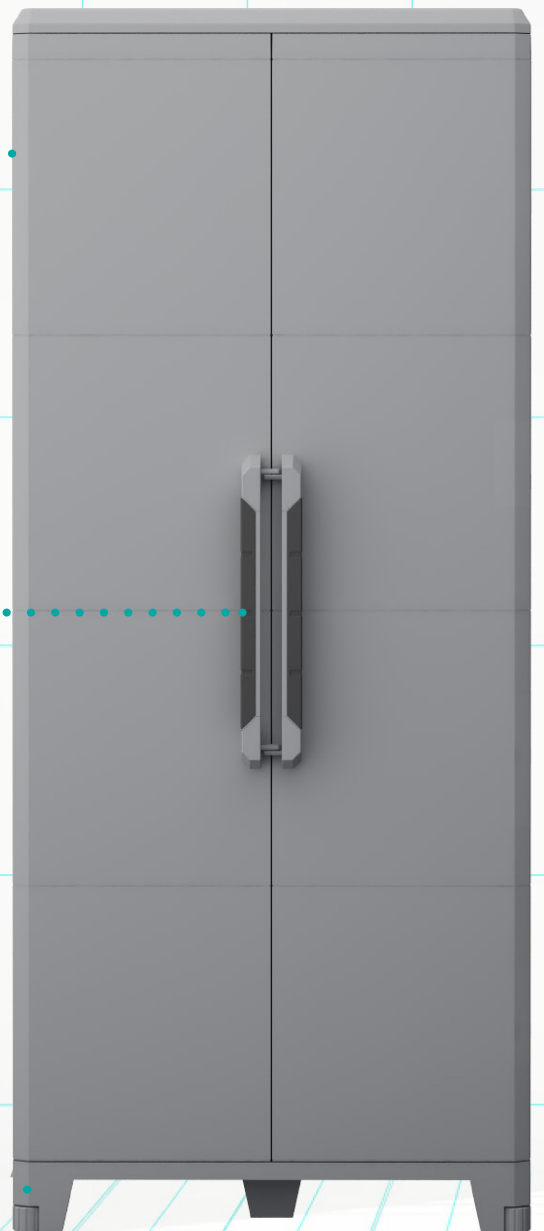

Modular

TRANSFORMING

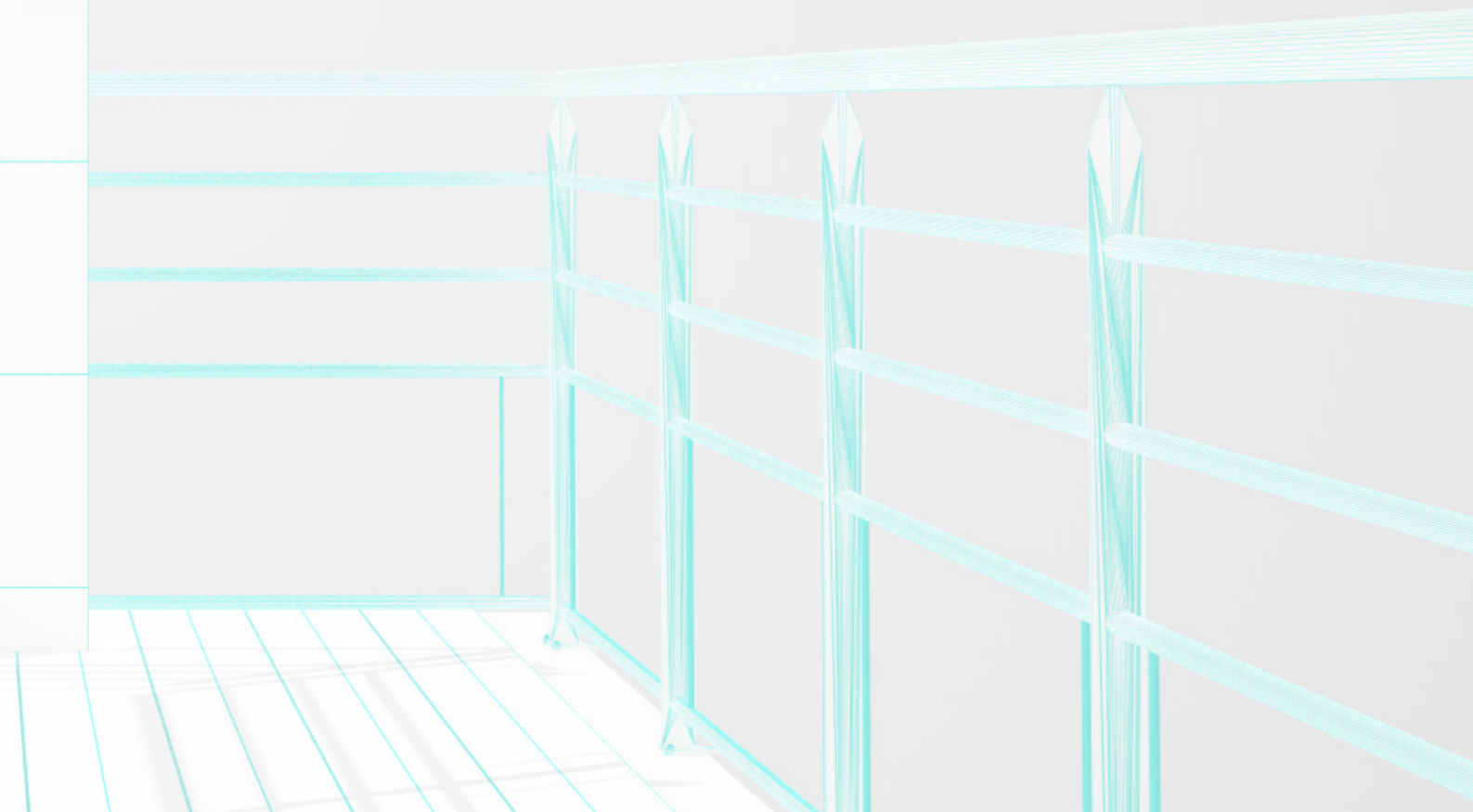

Transforming Modular System

PATENT PENDING

Modular inner shelf
Ripiano interno modulare
Tablette intérieure modulable
Modulare Innenfächer
Balda interior Modular

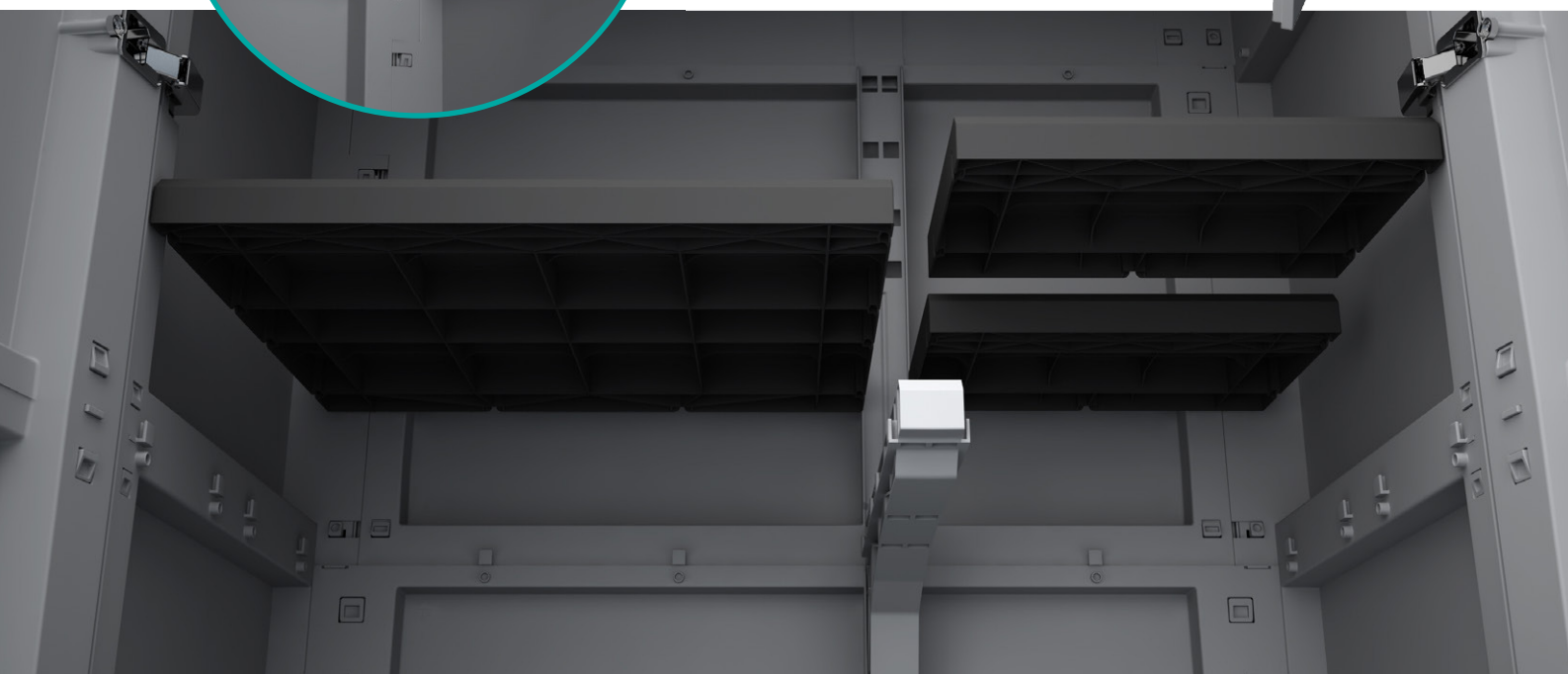
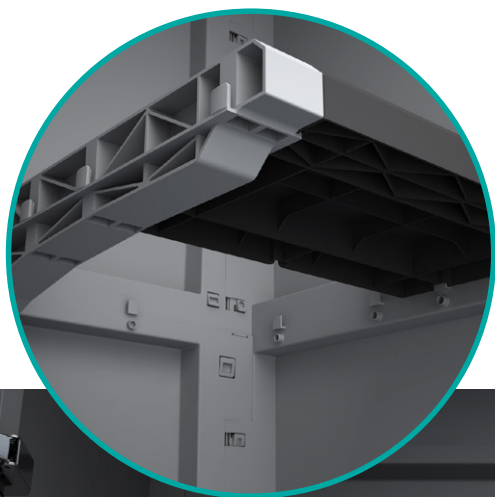
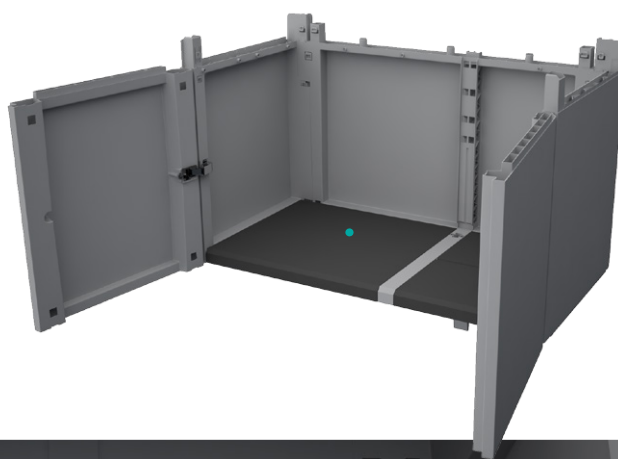

Customize your storage space

Componilo come vuoi

Composez selon vos envies

Gestalten Sie Ihren Schrank, wie Sie ihn wünschen

Para componer según tus necesidades

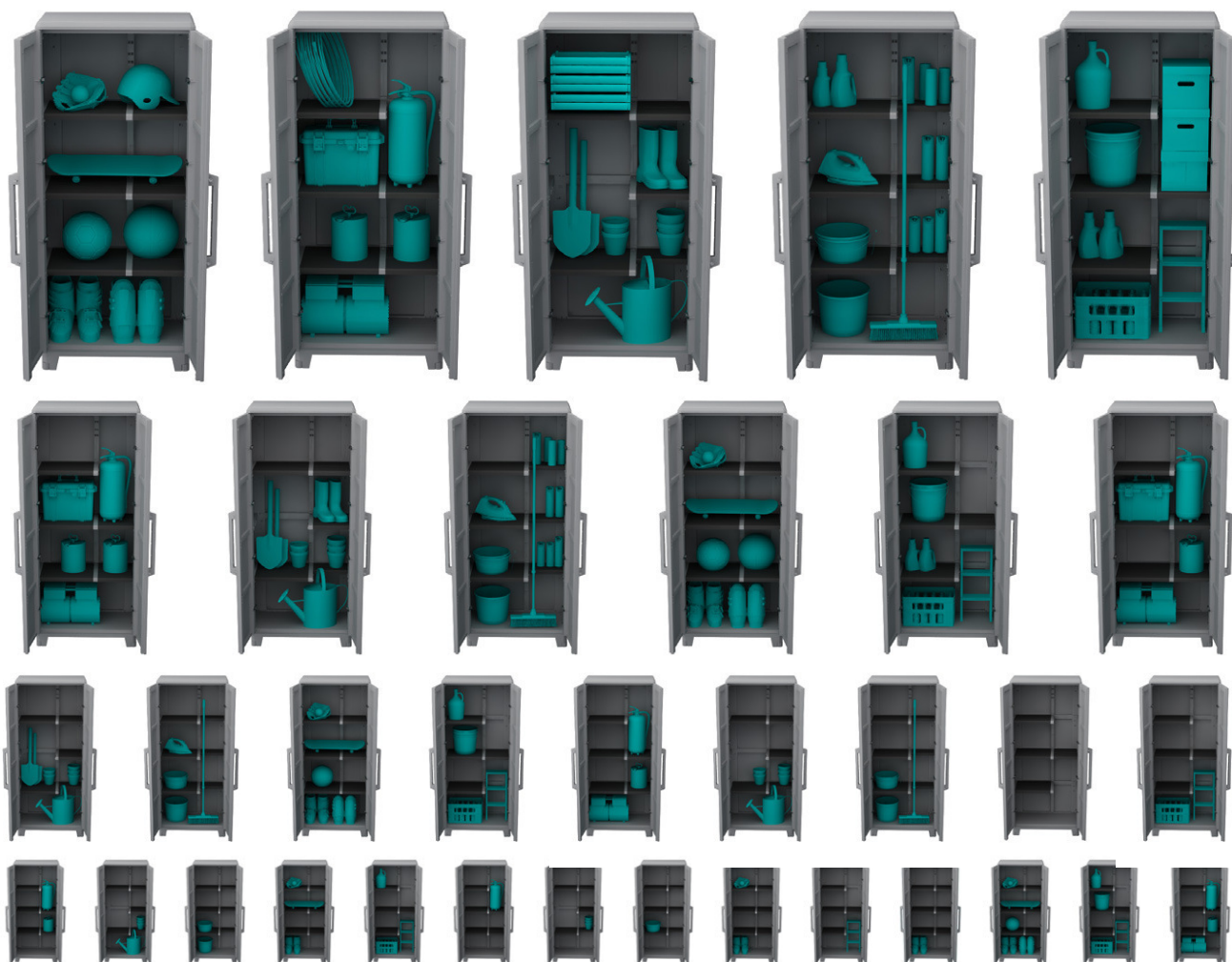

Sturdy structure

Sturdy structure - Interconnecting modules to form a sturdy structure

Struttura solida - La costruzione a moduli interconnessi e sovrapposti garantisce una struttura rigida

Structure solide - Construction avec modules superposés et interconnectés pour garantir une structure solide

Feste Struktur - Die Konstruktion aus Modulen, die miteinander verbunden sind und sich überlagern, gewährleistet eine feste Struktur

Estructuralmente Sólido - La construcción modular garantiza una estructura solida



Reinforced bottom with 6 feet (2 height adjustable front feet)

Fondo rinforzato con 6 piedi di cui 2 frontali regolabili in altezza

Base renforcée avec 6 pieds (les deux pieds devant sont réglables en hauteur)

Verstärkter Boden mit 6 Füßen, von denen die vorderen in der Höhe verstellbar sind

Base reforzada con 6 pies (de los cuales 2 regulables)



High-Capacity Shelf Storage

Grande Portata
Charge lourde
Großes Fassungsvermögen
Gran alcance



**PORTATA MASSIMA TOTALE - MAXIMUM LOAD CAPACITY - CHARGE TOTALE
MAXIMALE TRAGFÄHIGKEIT INSGESAMT - PESO MÁXIMO TOTAL: 240 KG**

Ideal for **outdoors**

Ideale anche per esterni
Idéal pour le rangement extérieur
Ideal auch für den Außeneinsatz
Ideal para exteriores

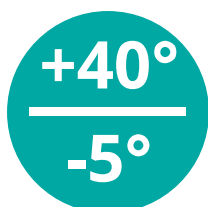

Temperature resistant
Resistente alle temperature
Resistant aux températures
Temperaturbeständigkeit
Resistente a las temperaturas



Anti-UV protection
Protezione ai raggi UV
Protection anti-UV
UV-Strahlenschutz
Protección a los rayos UV

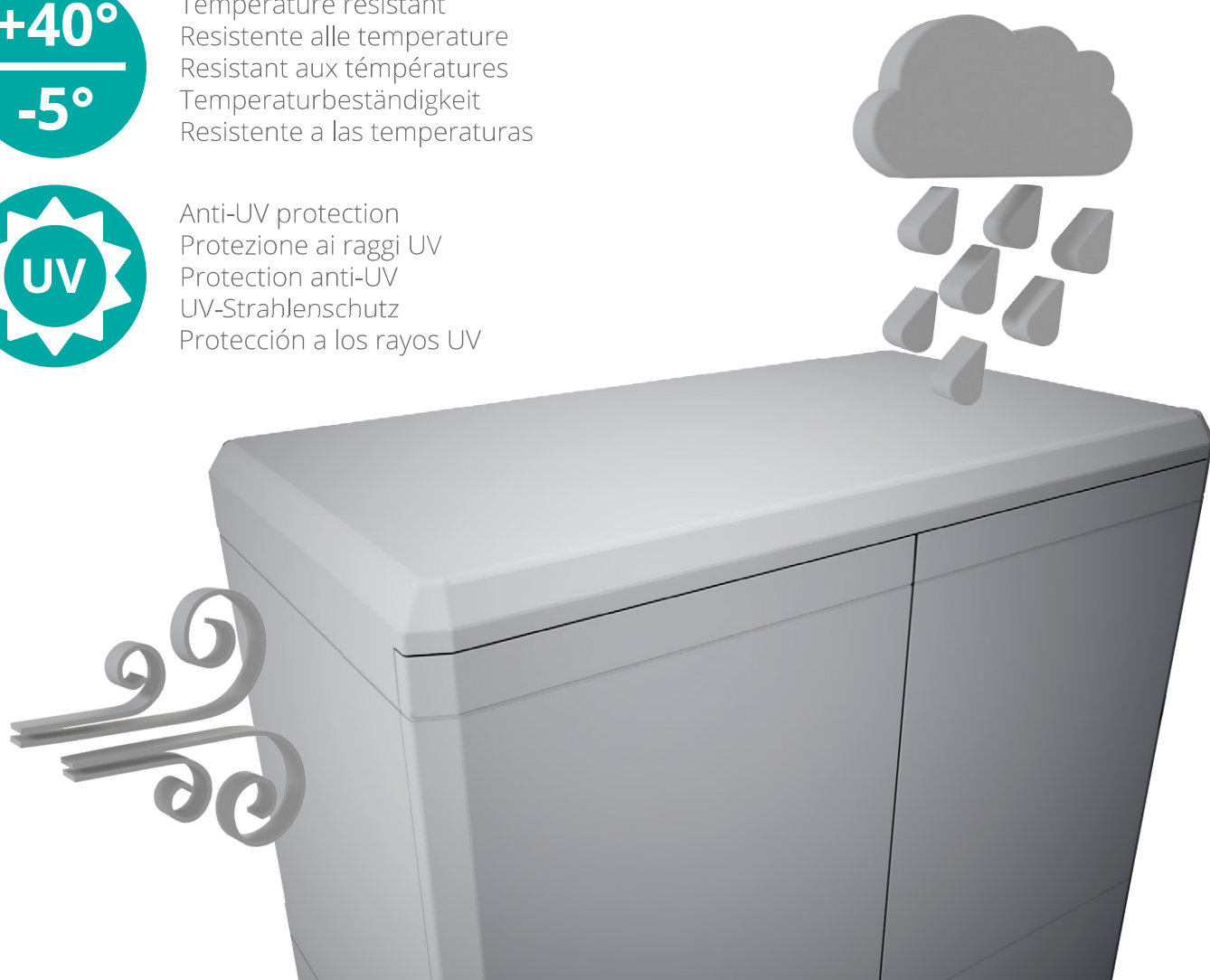



Expandable upon your needs

Può essere ampliato in base alle tue esigenze
Possibilité de l'agrandir selon vos exigences
Kann nach Belieben erweitert werden
Ampliable en función de tus exigencias

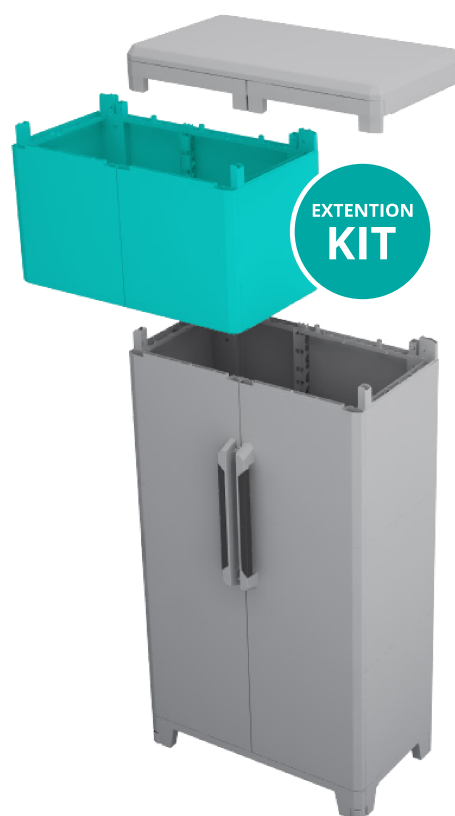
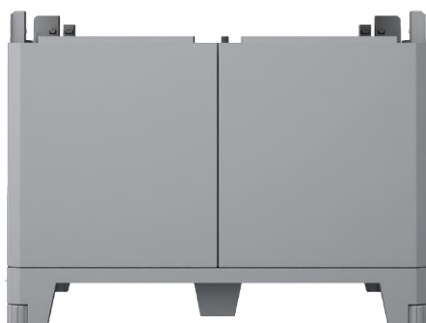
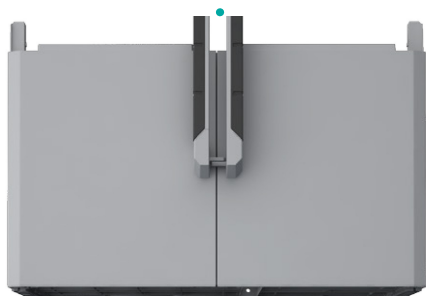

Grazie all' Extension Kit puoi fare crescere il tuo armadio
Add extra storage space with the Extension Kit
Augmentez votre espace de rangement avec le Kit Extension
Mit dem Extension Kit kann Ihr Schrank vergrößert werden
Gracias al Kit de extensión puedes hacer crecer tu armario

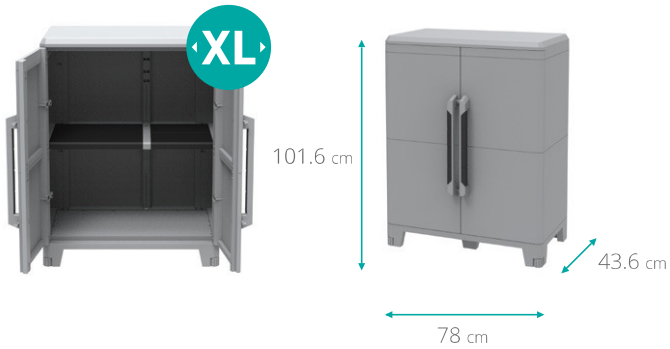

Modular²



Modular³



Modular⁴



Modular⁵