

BASE DA 80

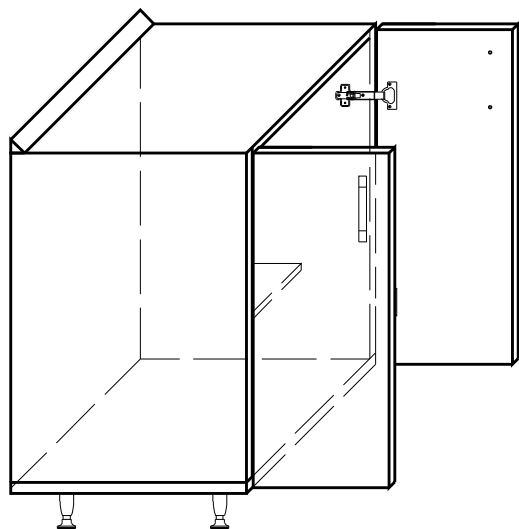

X16	
X8	
X2	
X1	
X4	
X2	
X4	

ISTRUZIONI DI MONTAGGIO
AUFBAUANLEITUNG
ASSEMBLY INSTRUCTIONS
NOTICE DE MONTAGE
INSTRUCCIONES DE MONTAJE

IDENTIFICARE LA FERRAMENTA DALLE DIMENSIONI (MM)

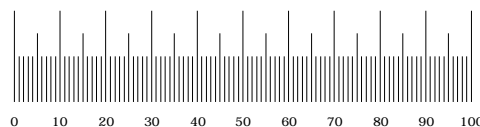

1

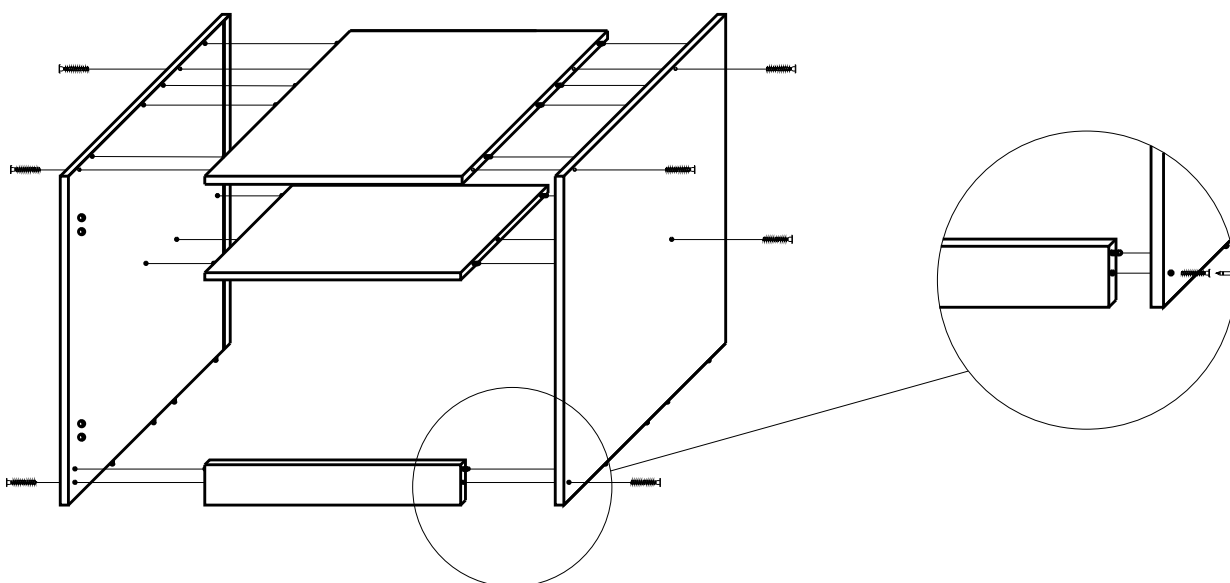

2

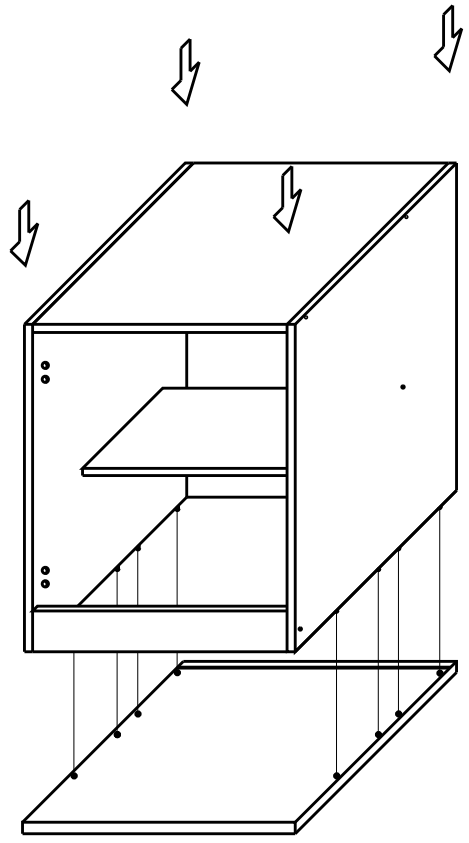
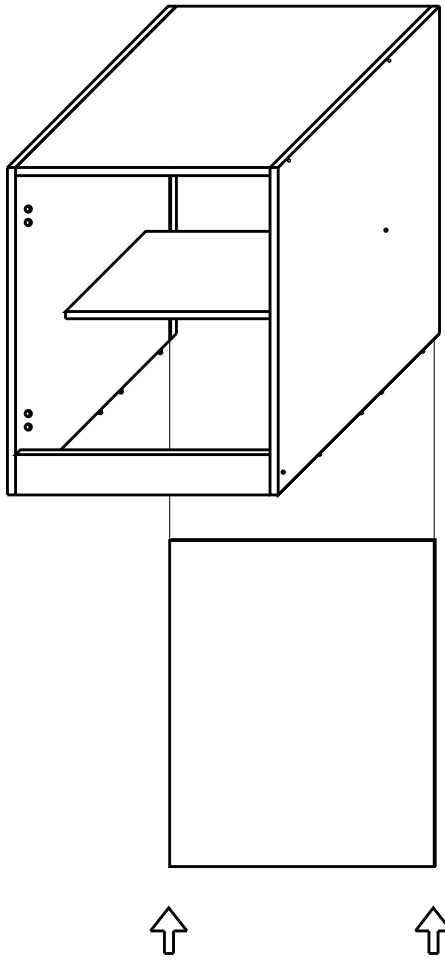

3

